

StudioLive™ Series III

Studio One DAW Control Addendum



Table of Contents

1	Introduction	— 1
2	Getting Started	— 1
3	Controlling Studio One	— 2
3.1	Making the Connections	— 2
3.2	Channel Controls	— 3
3.2.1	Arming Tracks	— 3
3.3	Fat Channel Controls	— 4
3.4	Touchscreen Controls	— 5
3.4.1	Inserts	— 6
3.4.2	Sends	— 7
3.4.3	Cue Mixes	— 8
3.5	Mix Management	— 8
3.6	Metering	— 8
3.7	Control Link	— 9
3.8	Transport	— 9
3.8.1	Transport Screen (Software Control Mode)	— 10
3.9	General Session Tools	— 11
3.9.1	Views	— 11
3.9.2	Save and Undo	— 11
3.9.3	Quick Keys	— 12
3.10	Active Mixer Controls	— 13

1 Introduction



Your StudioLive Series III console mixer provides extensive hardware control over Studio One. Control channel faders and automation, plugin parameters, transport functions, and more.

We suggest that you use this addendum to familiarize yourself with the features, applications, and correct connection procedures for your StudioLive mixer before trying to connect it to your computer to control Studio One. This will help you avoid problems during installation and setup.

2 Getting Started

To begin using your StudioLive Series III mixer as a controller for Studio One, connect it to an available Ethernet port on the same router to which your computer is connected (wired or wirelessly) or directly to an Ethernet connection on your computer.

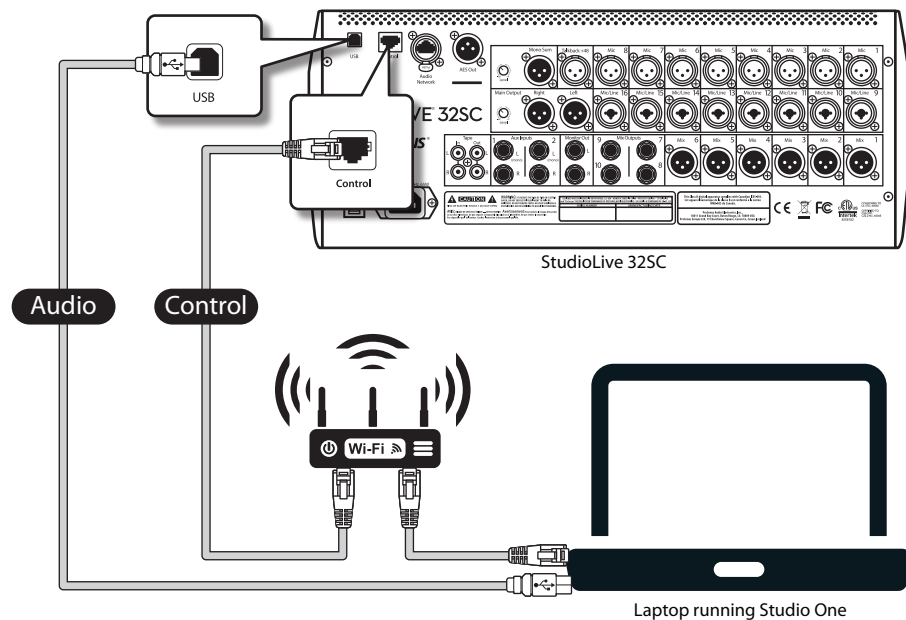

Please Note: At the time of publication, remote control over USB is not supported. You must network your mixer and your computer to use DAW mode in addition to connecting USB for audio transport so that your StudioLive can be used as an audio interface.

Important: If you are hardwiring your computer to the same router as your mixer, you must disable the wireless connection on your computer. UCNET does not support dual network connections.

Note: Ethernet-to-Thunderbolt and Ethernet-to-USBC adapters are also supported. Ethernet-to-USB adapters will not allow your computer to network to a StudioLive mixer.

3 Controlling Studio One

3.1 Making the Connections



1. Once you have networked your mixer and your computer, the next step is to launch Studio One. Studio One will automatically detect your mixer, no setup within the application is required.

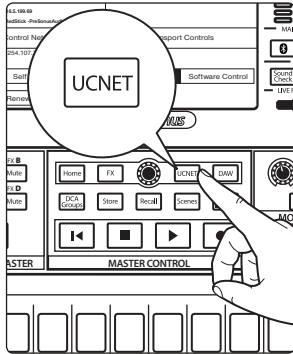

2. Press the UCNET button on your StudioLive mixer.

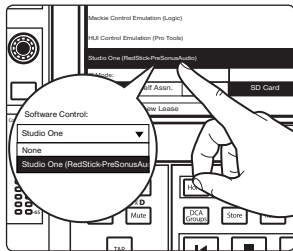

3. Tap on the Software Control menu on the Touchscreen and select Studio One from the drop-down list.

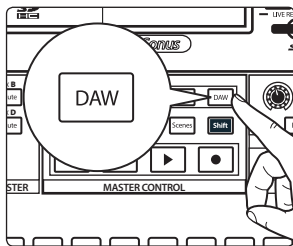

4. Press the DAW button on your mixer to start DAW control mode.

Power User Tip: DAW mode can be toggled on and off at will, allowing you to control your mixer's DSP engine and switch back to controlling Studio One with the touch of a button.

You are now ready to control Studio One!

3.2 Channel Controls



1. **Track Name.** Displays the track/bus name that the channel strip functions are controlling.
2. **Track Number.** Displays the track/bus number that the channel strip functions are controlling.
3. **Automation Mode.** Displays the currently selected automation mode for the track.
4. **Pan Position.** Displays the track's current pan position.
5. **Select button.** This button selects the corresponding track or bus in Studio One and changes color to match the channel color codes you have chosen in your session.
6. **Solo.** Isolates the corresponding track's output signal in the mix.
7. **Mute.** Mutes the corresponding track's output signal in the mix.
8. **Meters.** Displays the corresponding channel's signal level.
9. **Touch-Sensitive Fader.** This 100 mm motorized fader can be used to control volume levels for any channel or bus in your mix.

3.2.1 Arming Tracks

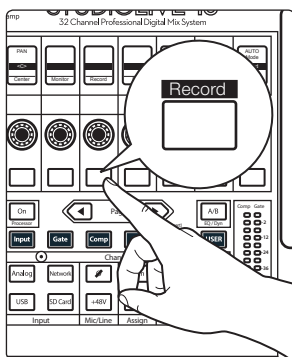

While Input mode is active in the Fat Channel, press and hold the button below the Record screen to enter Record Arm Mode. This will allow you to arm multiple tracks for recording by pressing their select buttons.



When a track is armed for recording, the track name will color-invert on the scribble strip display to indicate its arm status. Individual track arming can also be controlled from the Touchscreen and the Fat Channel. *See Sections 3.3 and 3.4 for more information.*

Power User Tip: Pressing and holding the Record Arm Mode button in the Fat Channel also allows you to quickly check the record arm status of all the tracks in your session. While holding the Record Arm Mode button, the Select button for any track that is already armed for recording will turn red.

3.3 Fat Channel Controls

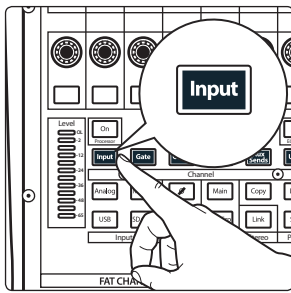

Press Input in the Fat Channel to access the following Channel controls:

Please note: Because of their unique Fixed Mode Fat Channel design, this functionality is not available for the StudioLive 32SX and StudioLive 32SC.

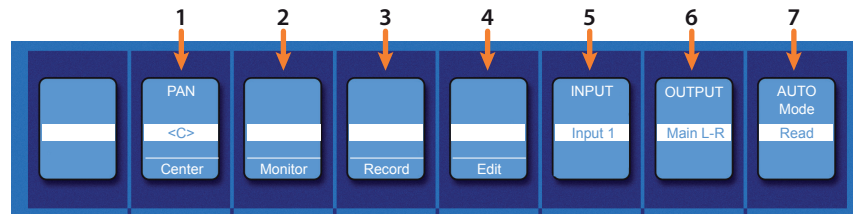

1. **Pan.** Use the encoder to adjust the panning of the currently selected channel. The current pan position will be displayed on the scribble strip display. Press the button to reset the pan position to the center.
Power User Tip: Panning can also be adjusted using the value encoder and the touchscreen on your mixer. See Section 3.4 for more information.
2. **Monitor.** Press this button to enable monitoring on the selected channel. Press and hold it to enable monitoring on multiple channels at once by pressing the Select buttons on the desired channels.
3. **Record.** Press this button enable record arm on the selected channel. Press and hold it to arm multiple channels for recording by pressing the Select buttons on the desired channels. *See Section 3.2.1 for more information.*
4. **Edit.** Press this button to open the Control Link editor for your StudioLive mixer in Studio One. From this window, you can assign any function in your session to the knobs and buttons in the Fat Channel section on your mixer. *See Section 3.7 for more information.*
5. **Input.** Turn the encoder to change the Input for the selected channel.
6. **Output.** Turn the encoder to change the Output for the selected channel.
7. **Automation Mode.** Turn the encoder to change the Automation mode for the selected channel. This mode can also be changed from the touchscreen, *see Section 3.4 for more information.*

3.4 Touchscreen Controls

When any track is selected in Studio One, the following controls are available on your StudioLive mixer's Touchscreen:

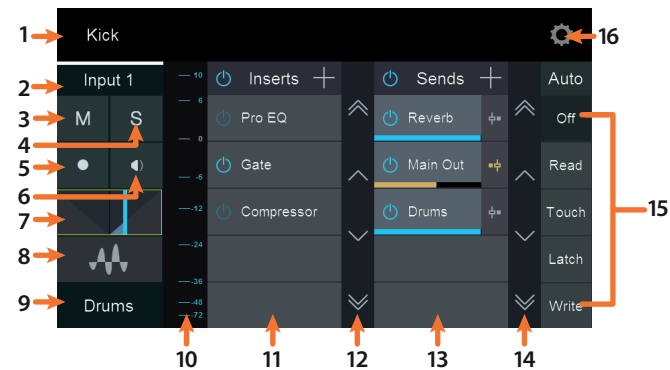

1. **Track Name.** Displays the name of the currently selected Track.
2. **Input.** Displays the Input source for the currently selected Track (Audio or MIDI input depending on track type).
3. **Mute.** Mutes the currently selected Track.
4. **Solo.** Isolates the currently selected Track.
5. **Record Arm.** Enables currently selected Track for recording.
6. **Monitor.** Enables input monitoring for currently selected Track.
7. **Pan.** Displays pan position. Tap to select and use the Value encoder to adjust.
8. **Type.** Displays Track type.
9. **Output.** Displays the Output destination for the currently selected Track.
10. **Metering.** Displays the metering for the currently selected Track.
11. **Inserts.** Displays the channel inserts. Tap the plus sign to insert a plug-in. Tap the plug-in name to instantiate its window in Studio One and its controls on the StudioLive Fat Channel. *See Section 3.4.1 for more information.*
12. **Insert Scroll.** Use these arrows to scroll through additional channel inserts.
13. **Sends.** Displays the currently selected channel's sends. Tap the plus sign to add a new Send. Tap any send in the list to engage Aux Sends mode on the StudioLive Fat Channel to adjust the send level. *See Section 3.4.2 for more information.*
14. **Sends Scroll.** Use these arrows to scroll through additional channel sends.
15. **Automation Modes.** Tap to select the automation mode for the currently selected Track.
16. **Channel Settings.** Tap to open the Channel Settings window. From here you can change the color of the currently selected track as well as its name.

3.4.1 Inserts

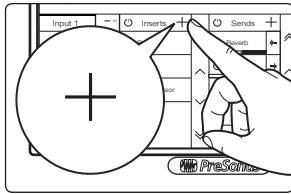

You can add and edit plug-ins to your session from the Touchscreen by pressing the Add Insert button.

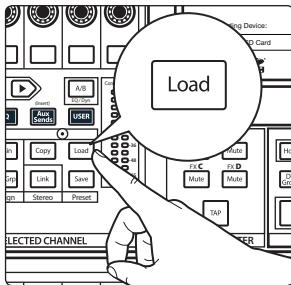

Power User Tip: You can also open the Add Insert Screen by pressing the Load button in the Fat Channel.

This will open the Add Insert screen on your mixer.

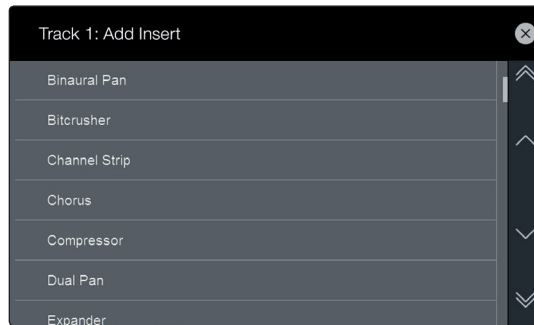

The Add Insert window in Studio One will also open.

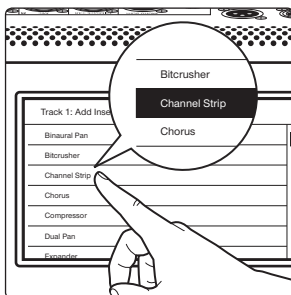
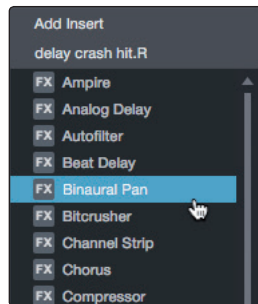

Select the plug-in you would like to insert by touching it on the Touchscreen or clicking it in Studio One.

Tap the "X" to cancel.

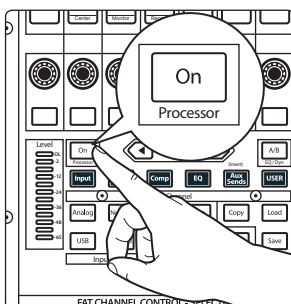

Power User Tip: Press the Processor On button to disable or enable the currently selected channel's FX Chain.

3.4.2 Sends

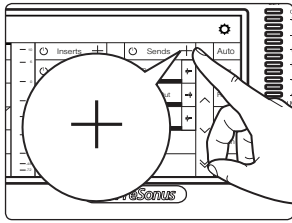

You can add and edit sends to your session from the Touchscreen by pressing the Add Sends button.

This will open the Add Sends screen on your mixer and the Add Sends window in Studio One.

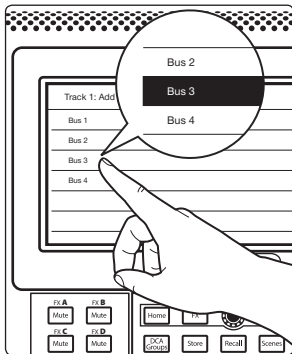

Select the send you would like to insert by touching it on the Touchscreen or clicking it in Studio One.

Tap the "X" to cancel.

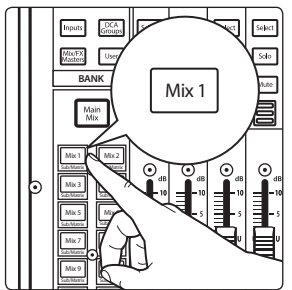

The first eight sends for every channel are also available on the faders by pressing the Mix 1-8 buttons. This will bring up the corresponding send slot for every channel. The active bus name for each will be displayed below the track name.

If no bus is active for the currently selected send slot on any given channel, this middle field will be blank.

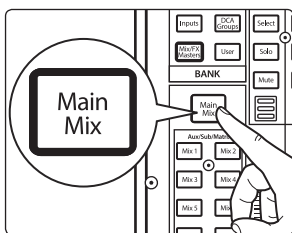

Power User Tip: Press the Main Mix button to return to the main Studio One mix.

3.4.3 Cue Mixes

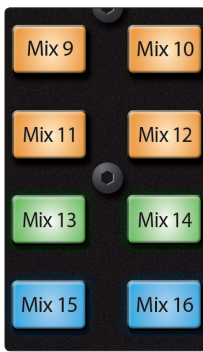

The first eight Cue Mix sends for every channel are available on the faders by pressing the Mix 9-16 buttons. This will bring up the corresponding Cue Mix send for every channel across the faders.

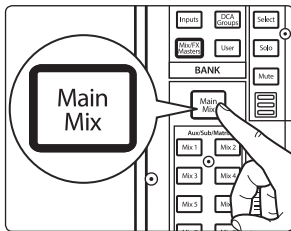

Power User Tip: Press the Main Mix button to return to the main Studio One mix.

3.5 Mix Management

StudioLive DAW Control mode allows you to filter which channels you view locally on the mixer:



By default, the USER layer is active when you enable DAW mode and every channel type is displayed on your StudioLive mixer.



Press the Inputs button to view Input channels only.



Press the Aux Inputs button to view the FX Channels.



Press the DCA Groups button to view the VCA Channels.



Press the Mix / FX Masters button to view the Bus Masters.

Power User Tip: On the StudioLive 24 and StudioLive 32, the FX Channels, VCA Channels, and Bus Masters will be displayed on the last bank of eight faders. In this way, you can split up large mixes and have access to critical channels quickly and easily.



Use the Next and Prev buttons to view more channels.

3.6 Metering

Metering is a critical part of the production process. Studio One's meters visually display audio levels according to your choice of metering style, and you can meter these levels at various stages in the signal path. For your convenience, these same meters are available on your StudioLive mixer and are scaled as follows:

- **Bottom Green LED:** -48 dBVU to -7 dBVU
- **Middle Green LED:** -6 dBVU to +9 dBVU
- **Top Red LED:** +10 dBVU

Power User Tip: The top "clip" LED will remain illuminated for 5 seconds after the signal drops below -0.5 dBFS

3.7 Control Link

Click on the pull-down menu in the Control Link display and select UCNET Remote to launch the StudioLive Fat Channel USER layer editor window.

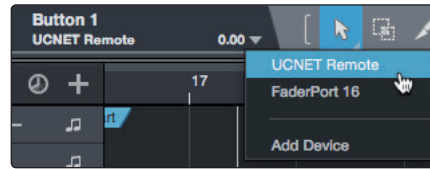

Right-click on any control in the Control Link window and select "Assign Command" to customize your Fat Channel USER layer.

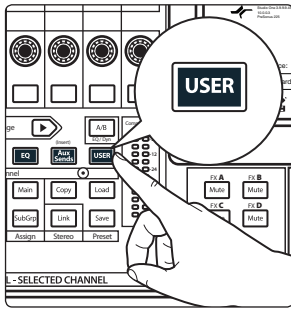

Press the USER button to access these controls remotely from your StudioLive.

3.8 Transport

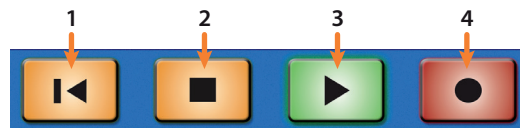

1. **Return to Zero.** Returns playback to the start position. Press with Option for Rewind. Press with CTRL to navigate to the previous marker.
2. **Stop.** Stops playback. Press with Option for Fast Forward. Press with CTRL to navigate to the next marker.
3. **Play.** Starts playback at current position.
4. **Record.** Starts Record at current position.



Press the Tap button to turn the Metronome on or off.

When DAW Mode is active, the Transport on your StudioLive mixer will always control your Studio One session. However, you have two options for control when you are in Live Mixing mode and DAW mode is inactive.

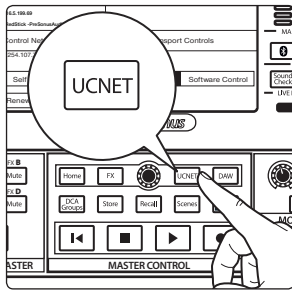

From the UCNET screen, you have the option to select which recording device the Transport will control: SD Card or Software Control.

When SD Card is active, the Transport will control the SD Capture session when DAW mode is inactive. When Software Control is active, the Transport will control the connected Studio One session whether DAW mode is active or not.

3.8.1 Transport Screen (Software Control Mode)

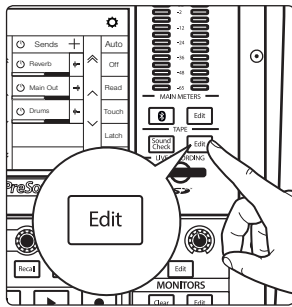

While Software Control mode is active, pressing the Edit button in the Live Recording section will open the Transport screen:

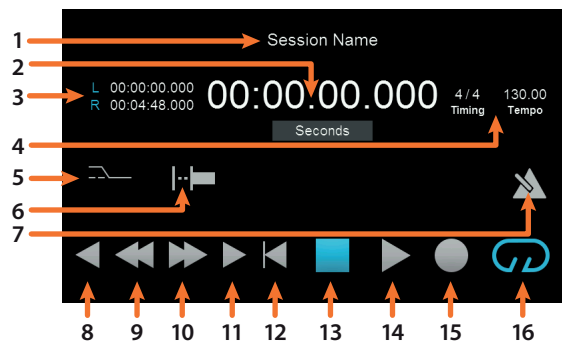

1. **Session Name.** Displays the current session's name.
2. **Current Position.** Displays the current position of the playback cursor.
3. **Loop Length.** Displays the current loop length.
4. **Time Signature and Tempo.** Displays the time signature and tempo of the current Studio One session.
5. **Record Mode.** Tap to enable / disable Record Replace Mode.
6. **Preroll.** Tap to turn Preroll on or off.
7. **Click.** Tap to turn Click on or off.
8. **Previous Marker.** Tap to go to the previous marker.
9. **Rewind.** Tap and hold to rewind playback position.
10. **Fast Forward.** Tap and hold to fast forward playback position.
11. **Next Marker.** Tap to go to the next marker.
12. **Return to Zero.** Tap to return the playback cursor to the zero position.
13. **Stop.** Tap to stop playback.
14. **Play.** Tap to start playback.
15. **Record.** Tap to engage record.
16. **Loop.** Tap to turn looping on or off.

3.9 General Session Tools

In addition to remotely controlling various aspects of your session, your StudioLive also provides more general controls to simplify your Studio One workflow. This section describes these additional functions.

3.9.1 Views

The four FX Mute buttons on your StudioLive allow you to open and close the following views in your Studio One session:

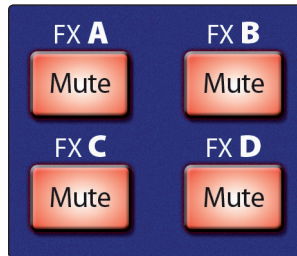

- **FXA Mute:** Open/Close Inspector
- **FXB Mute:** Open/Close Editor
- **FXC Mute:** Open/Close Mixer
- **FXD Mute:** Open/Close Browser

3.9.2 Save and Undo

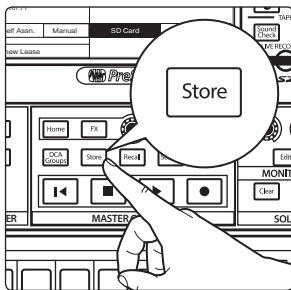

Press Store to save your session.

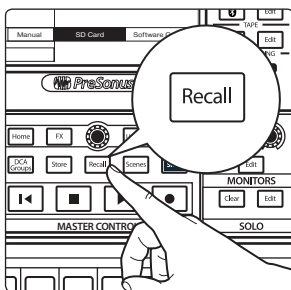

Press Recall to undo the last action.

Power User Tip: Press **SHIFT + Recall** to Revert your Session to a previous version.

3.9.3 Quick Keys

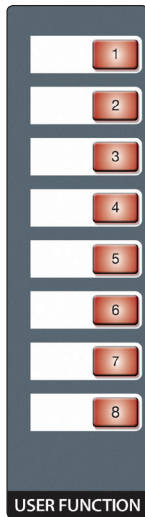

The User Function buttons can be assigned to any key command in Studio One. To program your favorite commands:

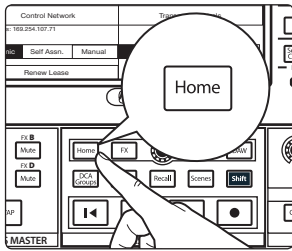

1. While DAW Mode is active, press the Home button.

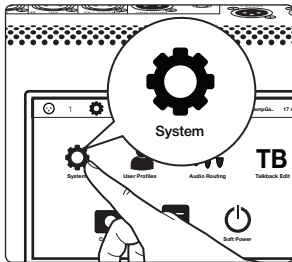

2. Touch the System icon on the Touchscreen.

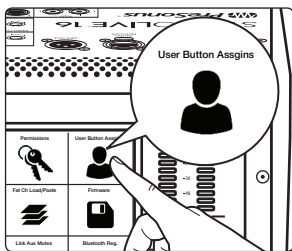

3. Touch the User Assign Buttons icon the Touchscreen.

4. Assign functions to any of the eight User Function buttons by pressing the Edit button next to the corresponding User Function button name in the Touchscreen.

3.10 Active Mixer Controls

While Studio One Control mode is active, the following mixer controls will still function as active controls for your StudioLive mixer, rather than your Studio One session:

- Monitor Bus Controls
- Solo Bus Controls
- Tape Controls
- Talkback Controls

Power User Tip: When a PreSonus Audio Interface with onboard Talkback (Quantum- or Studio 192-series) is selected as the audio interface for your Studio One session, the StudioLive Talkback controls the Studio One / Interface Talkback, not the StudioLive.

Added bonus: PreSonus' previously Top Secret recipe for...

Rice Dressing

Ingredients:

- 1 lb ground beef
- 1 lb chopped chicken liver
- 1 onion (diced)
- 2 green peppers (diced)
- 4-6 celery stalks (diced)
- 2 garlic cloves (minced)
- ¼ C. chopped fresh parsley
- 3 C. chicken stock
- 6 C. cooked rice
- 1 Tbs. oil
- Salt and pepper to taste
- Cayenne pepper to taste

Cooking Instructions:

1. In a large pot, heat oil on medium high and add meat, salt, and pepper to taste. Stir until meat begins to brown.
2. Lower heat and add all vegetables. Cook until onions are transparent and celery is very tender. Add stock as necessary to prevent burning.
3. Stir in cooked rice. Add remaining stock and simmer on low until ready to serve.

StudioLive™ Series III

Studio One DAW Control Addendum

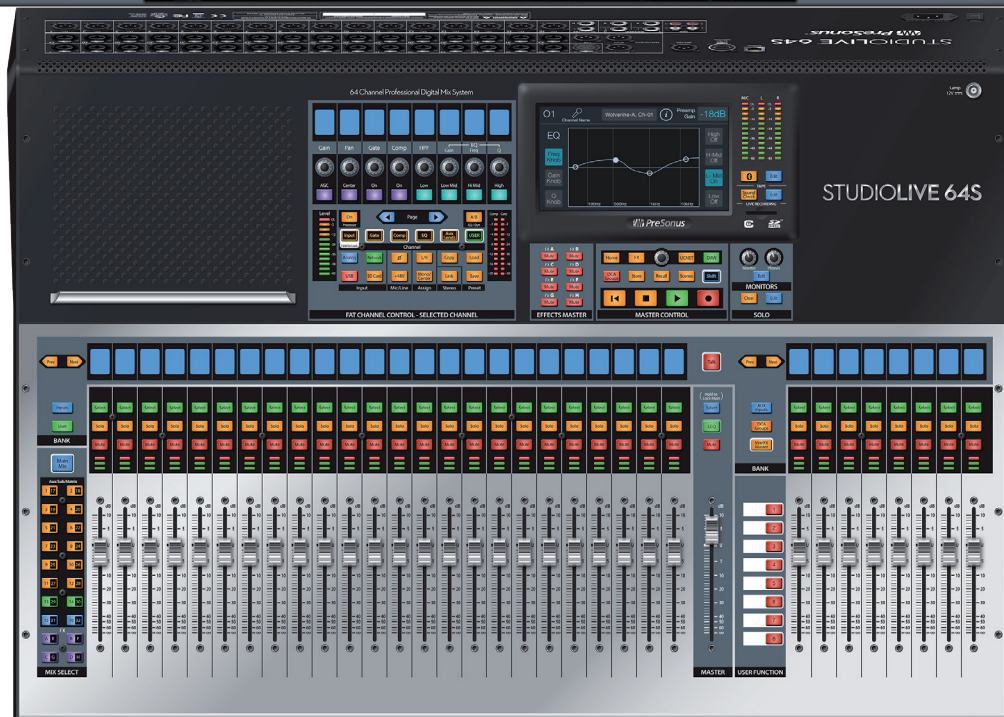

18011 Grand Bay Ct. • Baton Rouge,
Louisiana 70809 USA • 1-225-216-7887
www.presonus.com

Part# 70-2200069-C